

# W 450 HS

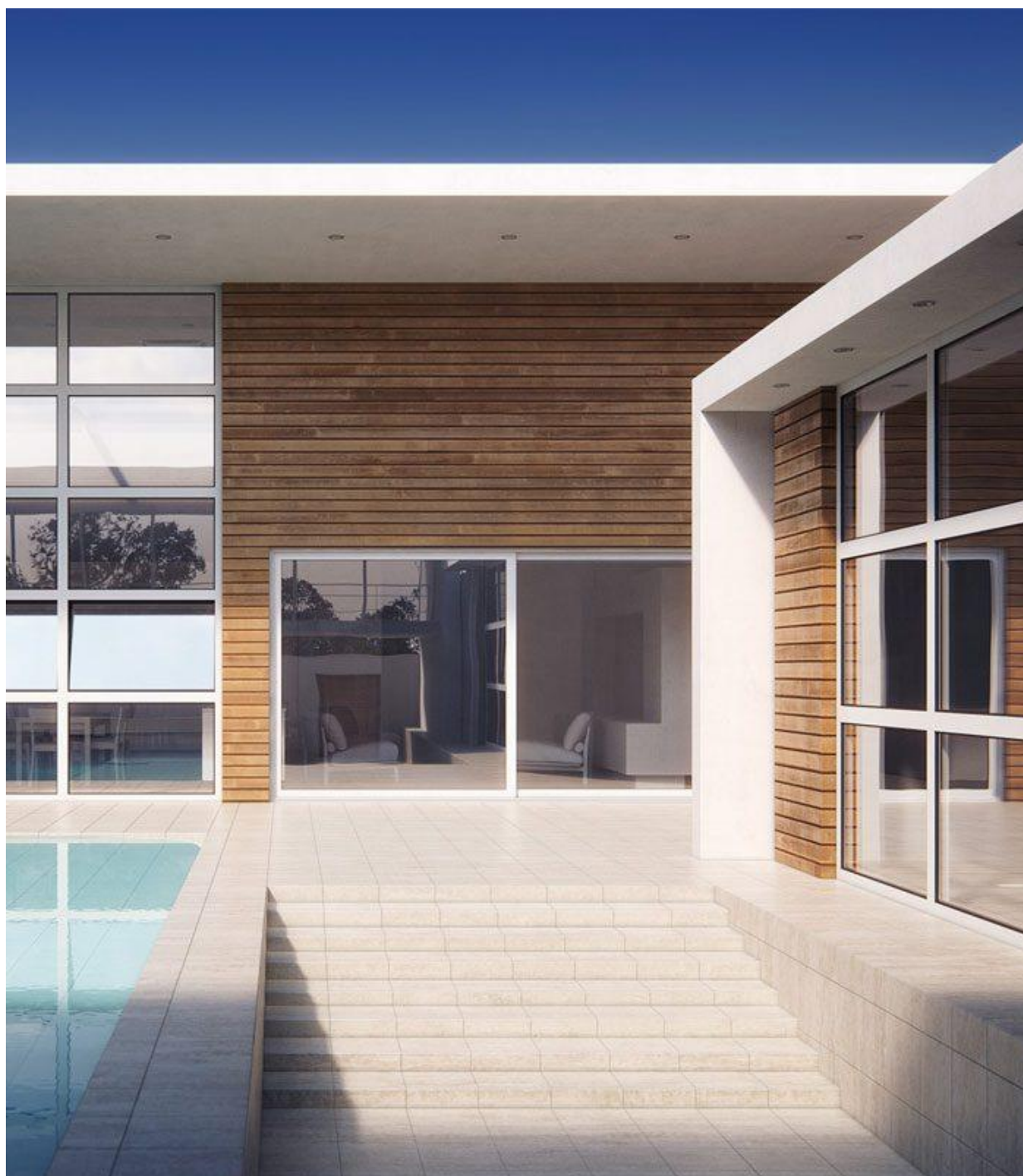

Tilt-and-turn window system with thermal insulation for an exceptional aesthetic result.

CE

EN 14351-1:2006+A2:2016

 window tech



The W450HS with hidden sash is a high-performance thermal insulation system that combines modern aesthetics with exceptional functionality, ensuring energy savings, security, and sound insulation.

Its contemporary architectural design is reflected not only in its modern appearance, but also in the minimum profile height of 72 mm, which maximizes the field of vision while allowing the maximum possible flow of natural light into the building.

The use of 30 mm glass fibre reinforced polyamides (PA66 GF25) ensures high thermal insulation with a  $U_f$  value starting from  $1.6 \text{ W/m}^2\text{K}$ , while the specially designed EPDM gaskets and the advanced perimeter mechanism ensure absolute water and wind tightness.

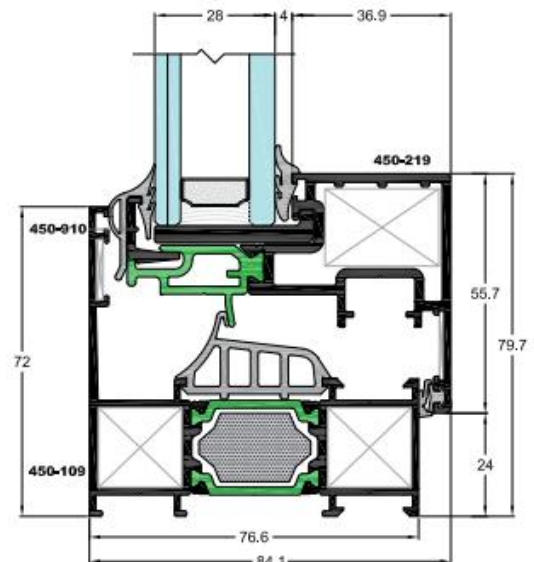

#### Features & Benefits

- Hidden sash with height of only 72 mm.
- Energy savings thanks to thermal performance
- Ease of use and high functionality
- High level of security thanks to multiple perimeters locking
- Multi-chamber central seal that guarantees optimal waterproofness
- Possibility of using hidden hinges
- Suitable for double glazing
- Wide range of typologies and solutions
- Modern design
- Ideal solution for homes and buildings.
- Window type: Casement
- Thermal insulation: Yes
- External shape: Flat

## Technical Characteristics

## Performance

FRAME DEPTH:	76.60 mm	RESISTANCE TO WIND LOAD (UNI EN 12210)	Clase C4
SASH DEPTH:	75.30 mm	WATER TIGHTNESS (UNI EN 12208)	Classe 7A
FRAME HEIGHT:	72.00 mm	AIR PERMEABILITY (UNI EN 12207)	Classe B4
MIN. WIDTH CENTRAL: COLUMN	116.40 mm	THERMAL TRASMITTANCE $U_f$ W/(m <sup>2</sup> K)	1.6 -2.8
SASH WEIGHT:	up to 180 Kg	THERMAL TRASMITTANCE $U_w$ (UNI EN ISO 10077-1)	1.76
GLAZING TYPE:	Double		
GLAZING THICKNESS:	28 mm		
THERMAL INSULATION:	Polyamides 30 mm, Insulation foam		

## TYOLOGIES



Fixed



One sash tilt  
and turn

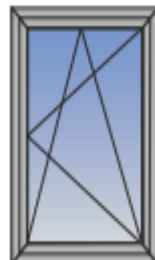

One sash tilt &  
turn low threshold

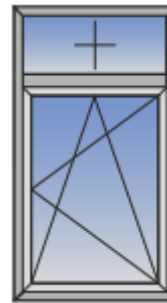

Single tilt & turn  
with fixed light



Single tilt & turn  
with fanlight

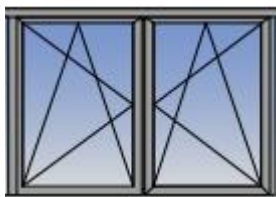

Double tilt and turn

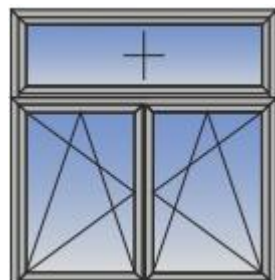

Double tilt and turn  
with fixed light

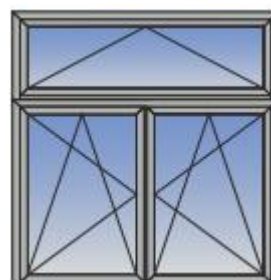

Double tilt and turn  
with fanlight



Double tilt and turn